

# EPS – 200 X

## High Current Power Supply



Installation and Operation Manual

Version 1.0

***\*This instrument is intended for laboratory use only***

## **Index**

<b>A. Important Notice</b> .....	<b>1</b>
A-1. Warranty	
A-2. Technical and Service Contact	
A-3. Safety Notice	
<b>B. Introduction</b> .....	<b>3</b>
B-1. Specifications	
B-2. Product Description	
B-2-1. EPS-200 X Power Supply Hardware Overview	
<b>C. Installation of EPS-200 X Power Supply</b> .....	<b>5</b>
C-1. Package List	
C-2. Setup and Operation of the EPS-200 X Power Supply	
C-2-1. Unpacking	
C-2-2. Setup and operation	
<b>D. Troubleshooting</b> .....	<b>8</b>
D-1. Basic troubleshooting	
D-2. Error codes	
D-3. Replacing the fuses	
<b>E. Care and Maintenance</b> .....	<b>11</b>
<b>F. Order Information</b> .....	<b>12</b>

## **A. Important Notice**

Before setting up and operating the instruments, please carefully read these instructions to get familiarized with the installation and operation process. Instructions should be read by experienced individuals before operating the instruments.

Any improper usage of the instruments may cause damage. Please refer to the safety notice included with this equipment.

The instruments shall not be modified or altered in any way. Any modification or alteration will void the warranty, void the regulatory certifications and create potential safety hazard. C.B.S. Scientific is not responsible for any injury or damage caused by using the instruments for any non-intended purpose or injury as a result of modification of the instruments by any person who is not authorized by C.B.S. Scientific Company, Inc.

### **A-1. Warranty**

EPS-200 X is warranted to be free from defects in materials or workmanship for a period of one year from the original invoice date, under normal usage. Any defects occurring during warranty period, C.B.S. Scientific will repair or replace defective products or parts without charge unless the defects arise from conditions outlined below. The defects described below are specially excluded from C.B.S. Scientific's warranty policy.

1. Improper operation of the instrument.
2. Repair or modification by any person who is not authorized by C.B.S. Scientific
3. Damage caused by any (in)-direct accident, neglect or misuse.
4. Damage caused by disaster.
5. Damage caused by any improper solvents or samples

### **A-2. Technical and Service Contact**

Most of the operation details are described in this instruction manual to assist and guide operator for an appropriate solution. For any other technical/ service questions, please contact your local representative or contact C.B.S. Scientific technical service specialist by E-mail: [technicalservice@cbssci.com](mailto:technicalservice@cbssci.com).

### A-3. Safety Notice

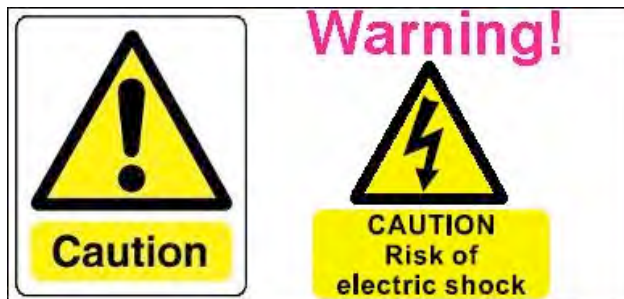

- EPS-200 X power supply uses high voltage output. To minimize the risk of electrical shock to the user the following guidelines should be observed and followed when using EPS-200 X power supply. Always read the product manual before operating the unit.
- EPS-200 X power supply shall be operated at temperature between 0°C and 40°C, with relative humidity between 10% and 90% non-condensing. Do not operate the EPS-200 X power supply in extreme humidity or where condensation can short the internal electrical circuits.
- Be sure that there is at least 6 cm clearance around the EPS-200 X power supply to ensure adequate cooling.
- Always connect the power supply using the AC power cord provided with the power supply or a similar 3-prong, grounded AC outlet.
- Use other than C.B.S. Scientific's electrical cable with plugs or banana jacks is done at the user's own risk when connecting the external instrument to the power supply's high voltage output jacks. While doing so, always grasp the plug by the molded support at the rear of the plug. Do not grasp the individual prong ends.
- When taking the power supply into a cold room, the unit can be operated immediately. However, when removing the power supply from the cold room, let the unit equilibrate to room temperature for a minimum of two hours before using it.
- Never connect a high voltage output lead to earth ground. This defeats the floating electrical isolation of the power supply and exposes the user to potentially lethal high voltages.

## B. Introduction

EPS-200 X power supply is compact, space saving and light weight in design. It can be used with many electrophoresis applications, such as running standard PAGE gels, multiple PAGE mini gels, horizontal/vertical agarose gels, semidry transfer and mini-gel tank transfer. The LED display reports power supply status. Parameters are set by pressing UP/DOWN arrow buttons in combination with a MODE button. Four pairs of output jacks accept 4 mm plugs, which operate in parallel. The output jacks are color coded, recessed for safety, and accept both 4 mm unshielded and shielded (banana) plugs. The user interface consists of a three digit, LED readout, and five buttons on a membrane keypad. Diagrams of the front and rear panel are shown on the following pages. The EPS-200 X operates in constant voltage or constant current modes. Power output is controlled by setting a maximum value for voltage (up to 200 V), or current (up to 2 A). The maximum output power at any time is 200 Watts. The Run duration can be continuous or programmed to a maximum duration of 1440 minutes. The EPS-200 X automatically “crosses over” or switches the limiting parameter according to the programmed limits as the resistance of the electrical load changes during a run.

### B-1. Specifications

Type	EPS-200 X
Input	96 - 240 VAC, 50-60 Hz
Output voltage (V)	5– 200 VDC adjustable in 1 V steps
Output current (A)	0.01-2, 0.01A steps
Maximum output power (W)	200 W
Output jacks	4 pairs
Output connector	4-mm plugs
Timer (Minutes)	1 – 1440 min., 1 min increment
User interface	3 digit, red LED membrane keypad
Dimension (L x W x H)	320 x 240 x 73 mm
Weight	Net ~2.4 kg (5.3 lb) Gross ~3.4 kg (7.5 lb)
Safety features	No load detection, Sudden load change protection, Over voltage protection, Automatic power failure recovery
Operating conditions	Indoor use: 0 – 40 °C Relative humidity: 0% to 90% Non-condensing Altitude: < 2000 m Installation category: II

## B-2. Product Description

### B-2-1. EPS-200 X Power Supply Hardware Overview

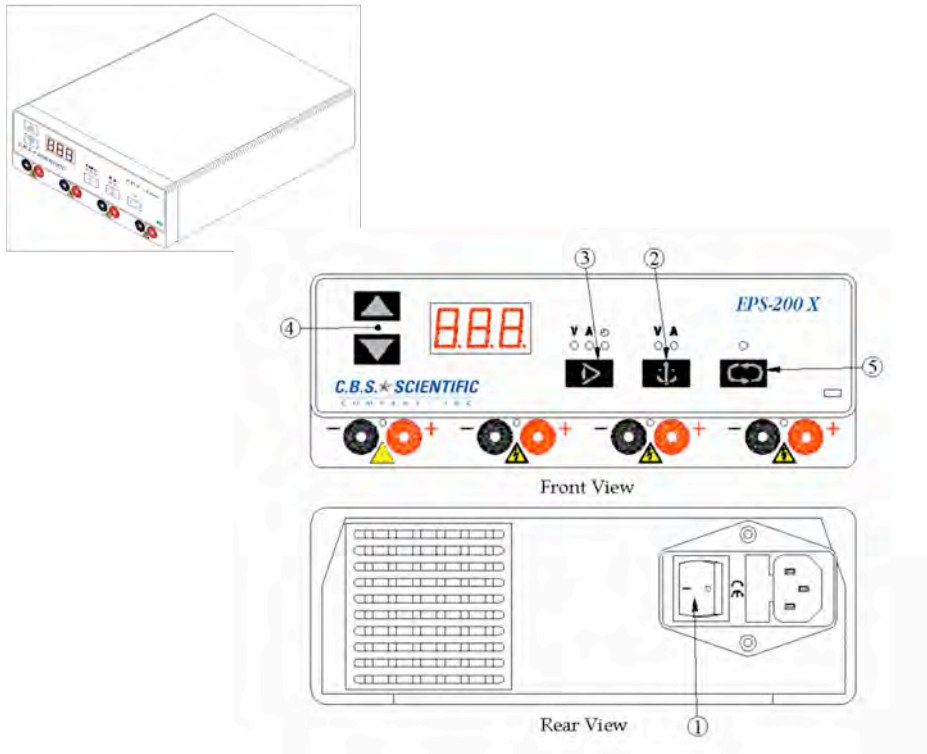



Button		Description
1	ON/OFF	ON/OFF Power Supply
2	CONST	Select voltage or current to be constant
3	MODE	Select the volts, milliamps, or time to be displayed
4	□□	Changes the displayed value of the selected parameter
5	RUN	Starts and Stops the output from the Power Supply

The front and rear panel buttons as shown above are used to set up and run the EPS-200 X power supply. The audible alarm design allows a beep sound for each and every button pressed on the front membrane keypad. A long beep alarm allows user to identify the run is complete or if an error occurs. It will continue every ten seconds until any button is pressed or the main power is turned off.

## C. Installation of EPS-200 X Power Supply

### C-1. Package List

Item	Quantity
<p><b>EPS-200 X power supply</b></p> 	<p>1</p>
<p><b>Power cable</b></p> 	<p>1</p>
<p><b>Instruction package</b></p> 	<p>1</p>

## C-2. Setup and Operation of the EPS-200 X Power Supply

### C-2-1. Unpacking

Unwrap all packages carefully and compare contents with the packing list, ensure the arrival of all the items. If any part is missing, contact your local C.B.S. Scientific representative. Inspect all the components for damage that may have occurred while the unit was in transit. If any part appears damaged, contact the carrier immediately. Be sure to keep all packing material for damage claims or to use should it become necessary to return the unit.

### C-2-2. Setup and Operation

**⚠ Caution:** Use only one hand when making or breaking a connection to avoid making a complete circuit across your chest. Also while connecting or disconnecting the leads, do not allow any part of your body to contact a grounded surface. Ensure your other hand is not touching anything that grounds you.

**⚠ Caution:** If you are in the middle of a run and wish to connect or disconnect the leads, always turn the power off (RUN button) and wait for the display to read “OFF”

- 1. Connect the main power cord:** Connect the main power cord to the power cord receptacle on the rear panel and to a suitable grounded AC power outlet.
- 2. Connect the HV power leads:** Connect the apparatus to the power supply by plugging the lead connectors into one pair of the recessed output jacks. The power leads are non-reversible as per to the color coordinated to the output jacks.
- 3. Turn on the main power switch:** Turn on the main power switch on the rear panel. The front panel and the main power LED indicator should be illuminated.
- 4. Select constant mode:** Press the CONST button to toggle between constant voltage and constant current mode. The selection is indicated by the green LED.
- 5. Adjust limit:** Press up and down buttons to set the constant variable to the desired value.
- 6. Check other run variable:** Press the MODE button to check and verify the set value of the other (non-constant) run variable. This variable is set by default to the maximum output of the power supply. This is the normal condition or setting for simple electrophoretic separations. Optional: If there is another upper limit desired for this non-constant variable, use the up and down buttons to set it to the desired value.
- 7. Set the timer (Optional):** Press the MODE button to move the green indicator LED light to under clock symbol.

**Continuous run:** Leave the timer at "0" to start a continuous run. The power supply will continue to operate indefinitely, until stopped manually. The timer will start counting up, indicating the length of the run in minutes. After reaching the maximum time of 999 minutes the timer will automatically reset and recount again from 0. Therefore for over night operation the resulting operation time is the addition of the current timer value with the previous maximum timer 1440 minutes.

**Timed run:** Press the up and down buttons to set the timer to the desired value (minutes). The timer counts down during the run, indicating the time remaining. At the end of the timed run, a ~3 second beep sounds and the display changes to "OFF". To reset the power supply press any button except the RUN button.

**PFD:** The Power Failure Detection feature will save the time, voltage and current settings in the event of a power outage and automatically continue the run when the power is restored. To alert the user that a power failure occurred during the run, the error message “E6” flashes at the end of the run instead of the usual “OFF” message. The “E6” error message means that despite the power outage, the power supply successfully supplied the programmed voltage and current for the entire length of time that was programmed. The time shown at the end of the run is the time the gel ran since power was restored, not the total time of the run. The default settings for Power Failure Detection are:

<b>Run</b>	<b>Time Setting</b>	<b>PFD</b>	<b>Code</b>
Timed Run	1 – 1440 minutes	ON	PF1
Continuous run	0	OFF	PF0

The Power Failure Detection feature can be deactivated during a timed run.

- Press the MODE button to move the indicator light under clock symbol.
- Press the UP and DOWN buttons to enter in the run time in minutes.
- Press both the UP and DOWN buttons at the same time. The display will briefly show “PF0”, indicating that the PFD mode is disabled.
- Press both the UP and DOWN buttons at the same time again. The display will show “PF1”, indicating that the PFD mode is enabled.

**8. Start the run:** Press the RUN button. The green LED light above the RUN button indicates that voltage and current are being applied to the output jacks. The green LED light above the CONST button indicates which parameter (V or A) is limiting. The LED display shows the numerical value of the actual V or A output, or the time (Press the MODE button to toggle between the values). The timer will count up in the case of a continuous run and count down if the timer was set for a specific timed duration.

**9. Stop the run:** A timed run will automatically stop with a warning beep as described above. In the case of a continuous run, press RUN button to terminate the run (The green LED light above the RUN button will turn off indicating that the voltage and current which was being applied to the output jacks were stopped.). The display reads “OFF”. To reset the power supply press any button except the RUN button.

## D. Troubleshooting

### D-1. Basic troubleshooting

 **Caution:** Wait 10 seconds while disconnecting the main AC input power cord to allow voltage discharge within the power supply when restarting.

<b>Symptom</b>	<b>Action and possible causes</b>
Fan is not spinning LED & Display do not light up Front panel power on indicator off	<ol style="list-style-type: none"> <li>1. Check main power source</li> <li>2. Check the fuse, replace a new same configuration fuse if necessary and try again</li> <li>3. Check if power switch malfunction</li> <li>4. Contact your local C.B.S. Scientific representative</li> </ol>
Fan is spinning LED & Display do not light up Front panel power on indicator off	<ol style="list-style-type: none"> <li>1. Check main power source</li> <li>2. Check if any errors on the front panel LED display</li> <li>3. Contact your local C.B.S. Scientific representative</li> </ol>
Fan is spinning LED & Display do not light up Front panel power on indicator on	<ol style="list-style-type: none"> <li>1. Contact your local C.B.S. Scientific representative.</li> </ol>
Fan is spinning Intermittent LED & Display Front panel power on indicator on	<ol style="list-style-type: none"> <li>1. Contact your local C.B.S. Scientific representative.</li> </ol>
Fuse blown	<ol style="list-style-type: none"> <li>1. Replace a new same configuration fuse and try again</li> <li>2. Contact your local C.B.S. Scientific representative</li> </ol>

## D-2. Error codes

The EPS-200 Xpower supply has built-in error messages to help troubleshoot problems with the electrical circuit. The error codes and possible corrective actions are listed below:

<b>Error Code</b>	<b>Explanation</b>	<b>Possible Solution</b>
<b>E1</b>	<p><b>No load detected</b></p> <p>The voltage leads to the electrophoresis cell are not plugged.</p> <p>The current load for the separation is below 4 mA the lower limit of the power supply.</p>	<ol style="list-style-type: none"> <li>1. Check all the connections</li> <li>2. Verify that buffer volumes are sufficient to contact all electrode wires and that buffer is contacting both surfaces of the gel.</li> <li>3. Press the any button* to clear the error code.</li> </ol>
<b>E3</b>	<p><b>Change in Load Resistance</b></p> <p>Open circuit was detected at some point after a successful start.</p> <p>Buffer is leaking from the cells.</p> <p>There is a loose electrical connection in the circuit.</p>	<ol style="list-style-type: none"> <li>1. Check and correct all potential resistance problems.</li> <li>2. Check buffer volumes.</li> <li>3. Check all voltage leads.</li> <li>4. Check the power supply adapters fitting (If used)</li> <li>5. Press any button* to clear the error code.</li> </ol>
<b>E4</b>	<p><b>Power Failure</b> during a Continuous run (no timer used)</p>	<ol style="list-style-type: none"> <li>1. Restart the run, if desired. Press any button* to clear the error code.</li> </ol>
<b>E5</b>	<p><b>Power Failure</b> during a timed run with PFD option disabled.</p> <p>Run was not complete.</p>	<ol style="list-style-type: none"> <li>1. Restart the run, if desired.</li> <li>2. Press any button* to clear the error code.</li> </ol> <p>See page 7 for information on the PFD option.</p>
<b>E6</b>	<p><b>Power Failure</b> during a timed run with PFD option enabled.</p> <p>Despite the power outage the run was completed successfully.</p>	<ol style="list-style-type: none"> <li>1. Press any button* to clear the error code.</li> </ol> <p>See page 7 for information on the PFD option.</p>

<b>E7</b>	<b>Short Circuit</b> Load current exceeded 2 A	<ol style="list-style-type: none"><li>1. Check for any short circuit or evidence of electrical arching.</li><li>2. Buffer concentration is too high.</li><li>3. Press any button* to clear the error code.</li></ol>
-----------	---	--

\*Press any button, except the RUN button, to clear the error message.

### **D-3. Replacing the fuses**

1. Unplug the power cord from the power supply.
2. Locate the fuse compartment on the rear panel.
3. Use a screwdriver to pry out the fuse compartment. There are two fuses in the compartment. Check and replace any blown fuses with a fuse of the same size and ratings.
4. FUSES (2); 250 V, 3.15 A, 5 x 20 mm fast blow.

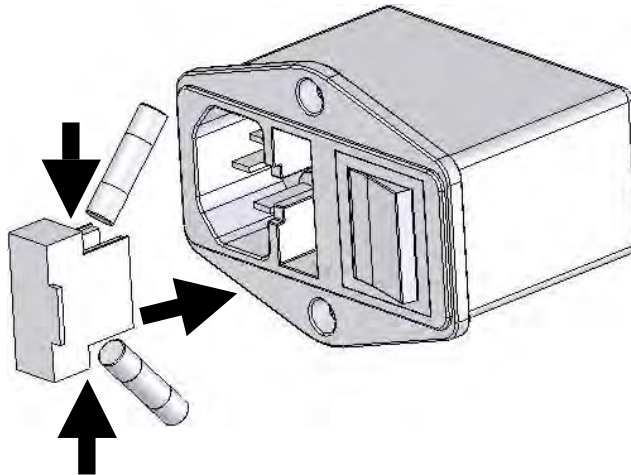

## E. Care and Maintenance

- Turn the main power switch off and unplug the power cord before cleaning.
- Use a soft cloth dampened with water or a mild cleaning solution to clean the cabinet and display.
- If spilled liquids contact the circuit boards, unplug the power supply and allow to dry completely. Please contact your local representative or C.B.S. Scientific technical service specialist by E-mail: [technicalservice@cbssci.com](mailto:technicalservice@cbssci.com)
- C.B.S. Scientific offers complete technical support for all of our products. If you have any questions about how to use this product, or would like to arrange to repair it, please contact your local C.B.S. Scientific representative or international technical service specialist by email: [technicalservice@cbssci.com](mailto:technicalservice@cbssci.com)

## F. Order Information

### EPS Power Supply

Description
EPS-200 X * High Current Power Supply, 96 - 240 VAC, 50-60 Hz, 5-200V, .01-2A, 200W max
EPS- 300 II* Power Supply, 120 V, 50-60 Hz, 10-300V, 4-500mA, 90W max
EPS-300 IIV* Power Supply, 230 V, 50-60 Hz, 10-300V, 4-500mA, 90W max
EPS- 600* Power Supply, 96 – 240 VAC, 50-60 Hz, 10-600V, 4-500mA, 90W max

*\*Standard package: Complete power supply unit, an instruction manual, power cable and a warranty card.*

---

Printed in Taiwan

**C.B.S. Scientific Company**

P.O. Box 856, Del Mar, CA 92014

Phone: 858-755-4959 email: [technicalservice@cbssci.com](mailto:technicalservice@cbssci.com)

[www.cbsscientific.com](http://www.cbsscientific.com)